

## STICK T5 SINGLE LAMP 3 FT. PENDANT & RAIL PENDANT

**DELRAY  
LIGHTING  
INCORPORATED**

**ST4 & ST6 - 3 ft.**



Shown with no trim (bare). For trim options, see back page.

<b>TYPE:</b>	<b>Model #</b>	<b>Voltage</b>	<b>Options*</b>	<b>Dimming*</b>	<b>Trim*</b>
<b>ORDER NUMBER:</b>		1-120V	SMB	SAC	SD5
<b>PROJECT:</b>		2-277V	SWRB	SFBS	SD8
			SFBW	SPF4	SD9
			SEM13**		SD11

\*See back page for details. \*\*6 ft. only.

Please review mounting info before ordering.

**Run Length:**  
(enter in multiples of 2 ft.)

Standard	Length	Wattage
ST46221	6'	2-21
ST46239	6'	2-39

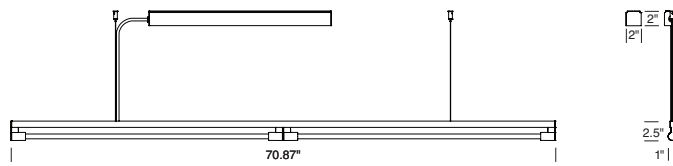

Rail Mount	Length	Wattage
ST66221	6'	2-21
ST66239	6'	2-39

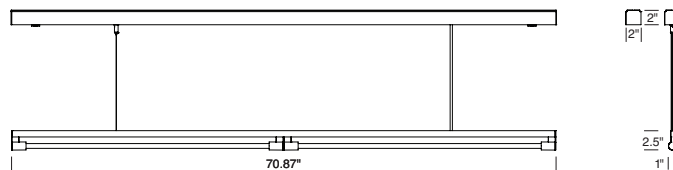

\*Rail parts ordered separately.

Standard	Length	Wattage
ST43121	3'	1-21
ST43139	3'	1-39

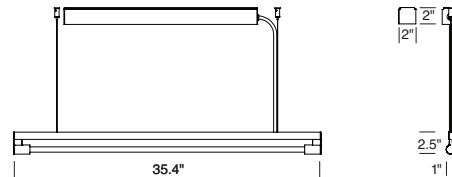

Rail Mount	Length	Wattage
ST63121	3'	1-21
ST63139	3'	1-39

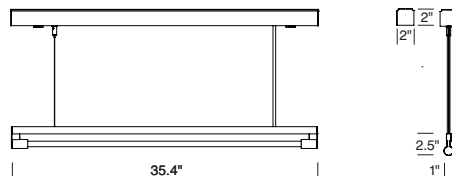

\*Rail parts ordered separately.

### STICK CONNECTING SECTIONS

STR open on right side of cord

STM open on both ends

STL open on left side of cord

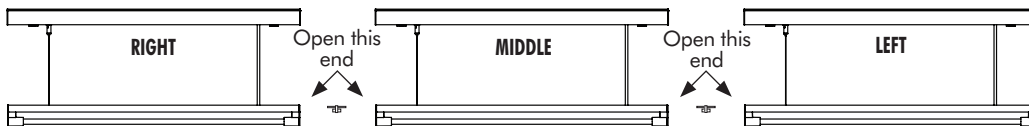

Standard	Length	Wattage
STR46221	6'	2-21
STR46239	6'	2-39
STR43121	3'	1-21
STR43139	3'	1-39

Standard	Length	Wattage
STM46221	6'	2-21
STM46239	6'	2-39
STM43121	3'	1-21
STM43139	3'	1-39

Standard	Length	Wattage
STL46221	6'	2-21
STL46239	6'	2-39
STL43121	3'	1-21
STL43139	3'	1-39

Rail Mount	Length	Wattage
STR66221	6'	2-21
STR66239	6'	2-39
STR63121	3'	1-21
STR63139	3'	1-39

Rail Mount	Length	Wattage
STM66221	6'	2-21
STM66239	6'	2-39
STM63121	3'	1-21
STM63139	3'	1-39

Rail Mount	Length	Wattage
STL66221	6'	2-21
STL66239	6'	2-39
STL63121	3'	1-21
STL63139	3'	1-39

BURBANK,  
CALIFORNIA,  
91505  
WWW.  
DELRAY  
LIGHTING.  
COM

## STICK CONSTRUCTION

### INLINE PENDANT

- ST43 & ST63 are 3' dual inline pendant fixtures that can stand alone or be connected to other 8', 4', or 2' Stick sections. (See connection order info on first page). Each section requires its own power feed.
- ST43 & ST63 may be connected to a continuous overhead rail system.
- Zinc aluminum alloy and aluminum extrusion, with a matte anodized finish.
- Suspended with field-adjustable aircraft cable, with push-button glider.
- G5 twist-in lamp holders.
- 8' gray 18 AWG power cord.
- Standard output electronic ballasts are 120/277V, 50/60 Hz universal, in a remote housing.
- Back plate has a  $\frac{7}{8}$ " opening for direct conduit feed and is not intended for J-box mount.
- U.L. listed for damp locations.
- EM available for 6 ft. only.

### TRIM OPTIONS



BARE

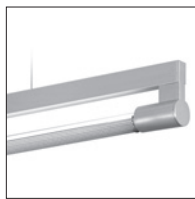

TRIM 11

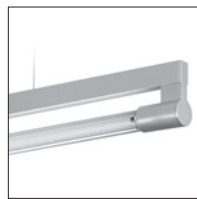

TRIM 12

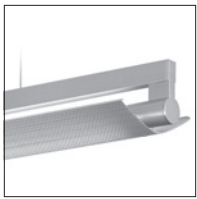

TRIM 13



TRIM 17



TRIM 18



TRIM 19



TRIM 20

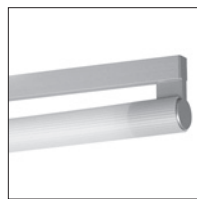

TRIM 21



TRIM 22



TRIM 23



TRIM 30

## OPTIONS

### DIMMING BALLASTS

Cat. #	Type	Wattage
SD5	Advance Mark VII	21
SD8	Lutron Hi Lume H3D	21/39
SD9	Lutron Eco System EC5	21/39
SD11	Lutron EcoSystem H-Series EHD	21/39

### BALLAST/RAIL MOUNT INFO

Stick ballast and rail housings are shipped with one opening for direct connection to conduit with a third party  $\frac{1}{2}$ " fitting (as shown below). To locate input power elsewhere, an alternate  $\frac{7}{8}$ " opening may be drilled at the job site anywhere along the top of the aluminum rail housing.

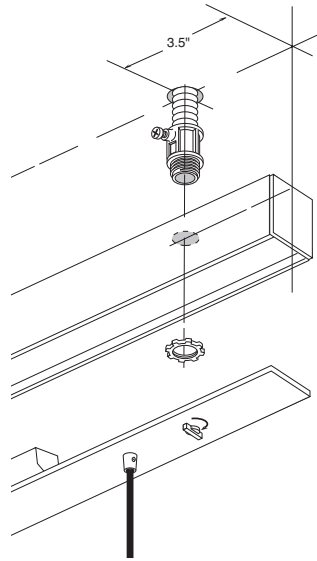

### RECESSED BALLAST

For suspended ceilings only. Order **SWRB**.

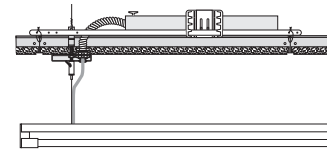

### FLUSH MOUNT

22" flush mount ballast housing, for joist mount rough-in. Order **SFBS** (silver) or **SFBW** (white).

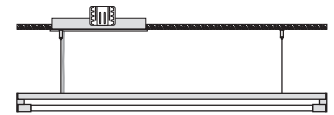

### EMERGENCY BALLASTS

Emergency ballast provides 1300 lumens for 90 minutes. Charge light and test switch are visible from below. On 2 lamp fixture, lamp closest to power cord gets emergency power. Maximum 4' pendant length recommended. Voltage must be specified. Order **SEM13**.

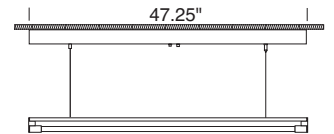

### CONTINUOUS MOUNT INFORMATION

Stick features a sliding support cable at the end opposite the power cord, for those times when a straight shot to the ceiling isn't possible.

**STJA**—swivel connector rotates 240° and adds  $\frac{7}{16}$ " to the overall length.

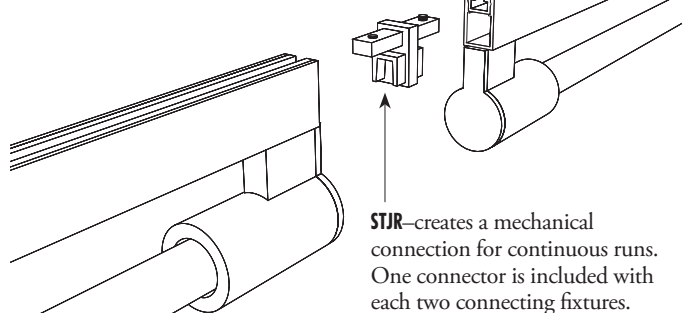

**STJR**—creates a mechanical connection for continuous runs. One connector is included with each two connecting fixtures.