

**STICK T5 SINGLE LAMP CANTILEVER**

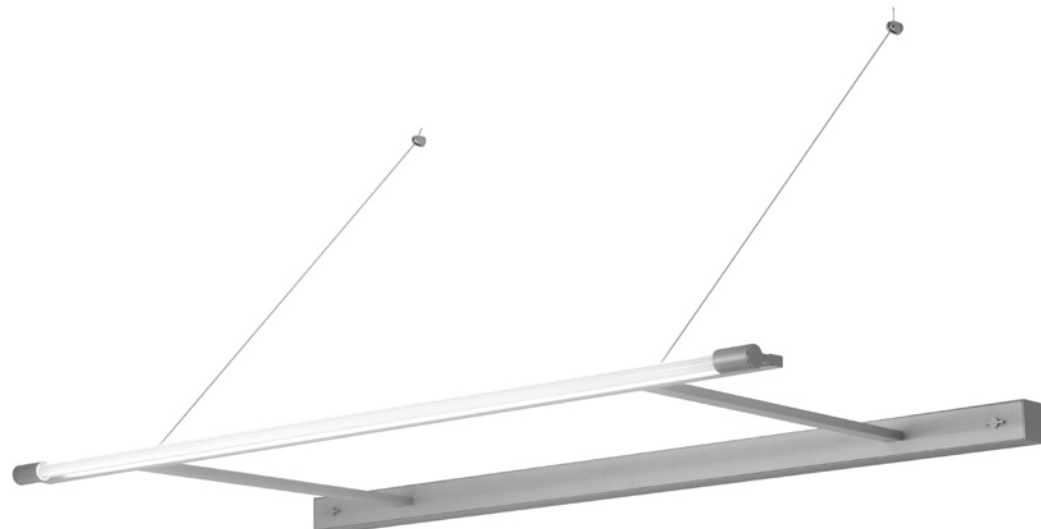

**TYPE:**

**ORDER NUMBER:**

**PROJECT:**

<b>Model #</b>	<b>Strut Length (in.)</b>	<b>Voltage</b>	<b>Options*</b>	<b>Dimming*</b>
	10, 12,	<b>1</b> -120V	<b>SEM</b>	<b>SD1</b>
	18, 24	<b>2</b> -277V	<b>S100P</b>	<b>SD3</b>
			<b>SRB</b>	<b>SD5</b>
				<b>SD8</b>
				<b>SD9</b>
				<b>SD10</b>

Ceiling Mount

Run Length: Custom Strut Length: \* See back page for details.

Please review mounting info before ordering. All rail parts must be ordered separately.

Standard	Length	Wattage	Top View	Side View
ST98228	8'	2-28		
ST98254	8'	2-54		
ST96221	6'	2-21		
ST96239	6'	2-39		

Standard	Length	Wattage	Top View	Side View
ST94128	4'	1-28		
ST94154	4'	1-54		
ST93121	3'	1-21		
ST93139	3'	1-39		

**ST9 CONNECTING SECTIONS (TOP VIEW)**

STR open on right side of cord

STM open on both ends

STL open on left side of cord

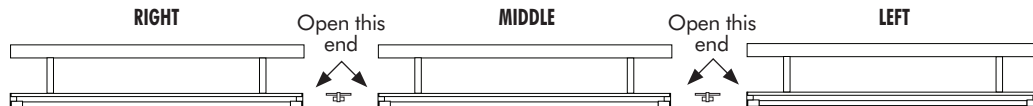

Standard	Length	Wattage	Standard	Length	Wattage	Standard	Length	Wattage
STR98228	8'	2-28	STM98228	8'	2-28	STL98228	8'	2-28
STR98254	8'	2-54	STM98254	8'	2-54	STL98254	8'	2-54
STR96221	6'	2-21	STM96221	6'	2-21	STL96221	6'	2-21
STR96239	6'	2-39	STM96239	6'	2-39	STL96239	6'	2-39
STR94128	4'	1-28	STM94128	4'	1-28	STL94128	4'	1-28
STR94154	4'	1-54	STM94154	4'	1-54	STL94154	4'	1-54
STR93121	3'	1-21	STM93121	3'	1-21	STL93121	3'	1-21
STR93139	3'	1-39	STM93139	3'	1-39	STL93139	3'	1-39

**DELRAY  
LIGHTING  
INCORPORATED**

**ST9  
BARRE**

BURBANK,  
CALIFORNIA,  
91505  
WWW.  
DELRAY  
LIGHTING.  
COM

## 4' 54W

### 1-54W T5

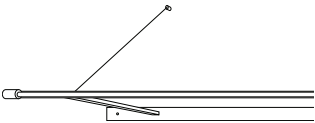

### ST94154

1-54W HO T5  
G5 socket  
Total lumens: 5000 mean  
Total luminaire efficiency: 95.9%

### CP DISTRIBUTION

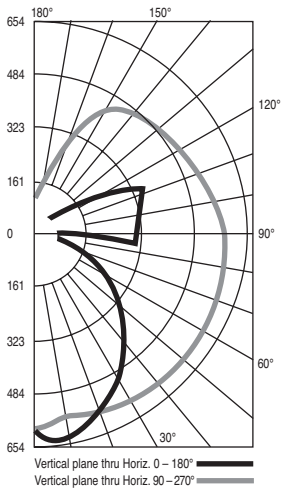

### COEFFICIENTS

% CEILING 80 (20% FLOOR)	% WALL 70	
	50	30
0	97	97
1	83	78
2	74	66
3	67	59
4	61	50
5	55	44
6	51	39
7	47	35
8	43	32
9	40	29
10	38	26

## ST9 CONSTRUCTION

### INLINE PENDANT

- The **ST98** (8 ft.), **ST96** (6 ft.), **ST94** (4 ft.), and **ST93** (3 ft.) series are wall mount cantilevered fixtures that may be used as stand-alone units or connected in continuous runs.
- Wall arms are available in lengths of 6, 12, 18 and 24 inches, standard. Also available in custom lengths (specify). Arm lengths over 6 inches require aircraft cable support (4 ft. cable and angle-adjusting cable grippers supplied).
- Zinc aluminum alloy and aluminum extrusion, with a matte anodized finish.
- G5 twist-in lamp holders.
- Standard output electronic ballasts are 120/277V, 50/60 Hz universal, in a remote housing.
- Back plate has a 7/8" opening for direct conduit feed and is not intended for J-box mount.
- U.L. listed for damp locations.

### CONTINUOUS MOUNT INFORMATION

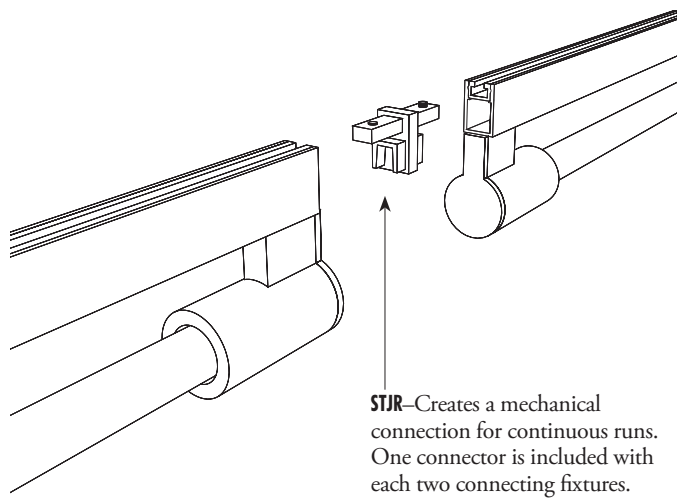

### SRB REMOTE BALLAST MOUNT

**SRB OPTION:** Make lamp wire connections in a horizontally mounted 2x4 handy box. The ballast box must be accessible after installation. Lamp to ballast distance must not exceed 16 feet.

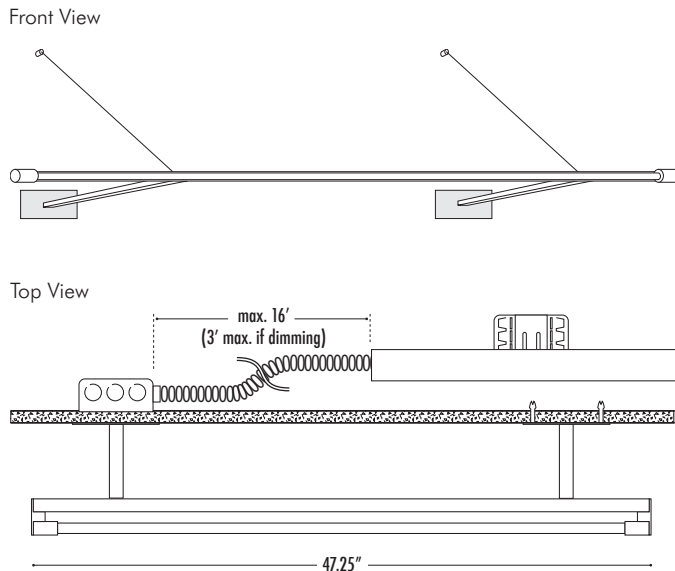

## OPTIONS

### EMERGENCY BALLASTS

Emergency ballast provides 650 lumens for 90 minutes. Charge light and test switch are visible from below. EM for 28/54W lamps *only*. Voltage must be specified. Order **SEM**.

### DIMMING BALLASTS

**Note:** Dimming available for 4 ft. lamps only; maximum arm length: 3 ft.

Cat. #	Type	Wattage
<b>SD1</b>	Lutron Eco 10	28/54
<b>SD3</b>	Advance Mark X	54
<b>SD5</b>	Advance Mark VII	54
<b>SD8</b>	Lutron Hi Lume FDB	28/54
<b>SD9</b>	Lutron Eco System	28/54
<b>SD10</b>	Stepped dim, 50% for 2x28 only	2x28

### BALLAST/RAIL MOUNT INFO

Stick ballast and rail housings are shipped with one opening for direct connection to conduit with a third party 1/2" fitting (as shown below). To locate input power elsewhere, an alternate 7/8" opening may be drilled at the job site anywhere along the top of the aluminum rail housing.

