

STICK T5 SINGLE LAMP CEILING STEM MOUNT

**DELRAY
LIGHTING
INCORPORATED**

**ST8
BARE**

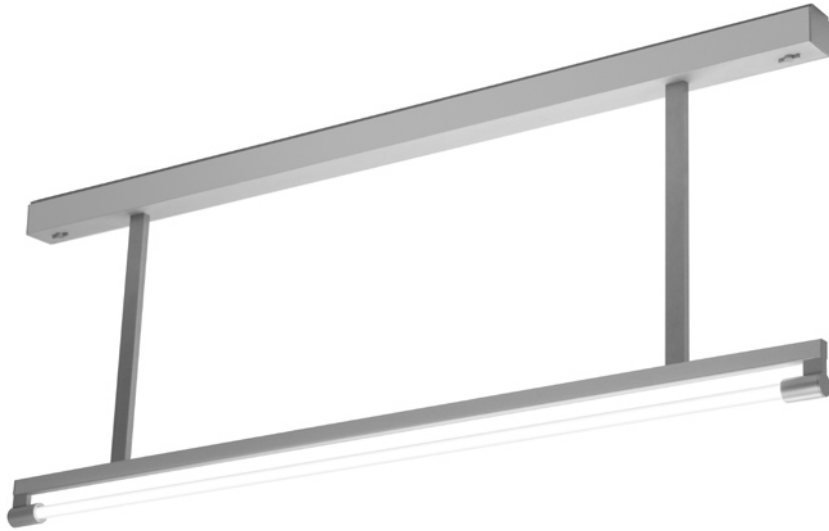

TYPE:	Model #	Projection	Voltage	Options*	Dimming*
ORDER NUMBER:		6, 12, 18, 24 (inches)	1 -120V 2 -277V	SEM S100P SRB8S SRB8R	SD3 SD9 SD5 SD10 SD8
PROJECT:	Run Length:	Custom Projection (inches):			
	* See back page for details.				
	Please review mounting info before ordering. All rail parts must be ordered separately.				

Stand Alone	Length	Wattage		Projection
ST88228	8'	2-28		10-48" 2"
ST88254	8'	2-54		70.8" - 94.5"

Stand Alone	Length	Wattage		Projection
ST84128	4'	1-28		10-48" 2"
ST84154	4'	1-54		35.4" - 47.25"

ST8 CONNECTING SECTIONS

STR open on right side of cord

STM open on both ends

STL open on left side of cord

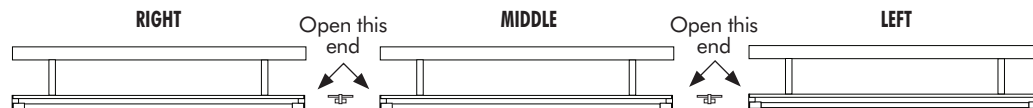

Model #	Length	Wattage	Model #	Length	Wattage	Model #	Length	Wattage
STR88228	8'	2-28	STM88228	8'	2-28	STL88228	8'	2-28
STR88254	8'	2-54	STM88254	8'	2-54	STL88254	8'	2-54
STR84128	4'	1-28	STM84128	4'	1-28	STL84128	4'	1-28
STR84154	4'	1-54	STM84154	4'	1-54	STL84154	4'	1-54

BURBANK,
CALIFORNIA,
91505
WWW.
DELRAY
LIGHTING.
COM

4' 54W

1-54W T5

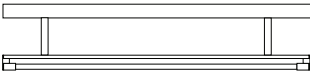

ST84154

1-54W HO T5
G5 socket
Total lumens: 5000 mean
Total luminaire efficiency: 95.9%

CP DISTRIBUTION

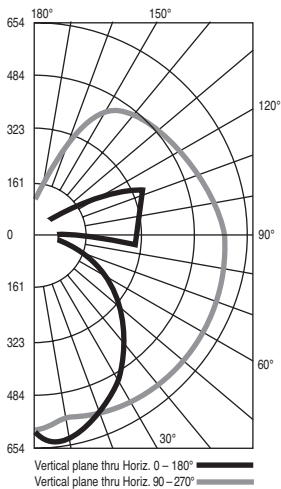

COEFFICIENTS

% CEILING 80	(20% FLOOR)		
	70	50	30
0	97	97	97
1	83	78	73
2	74	66	59
3	67	57	49
4	61	50	41
5	55	44	35
6	51	39	31
7	47	35	27
8	43	32	24
9	40	29	21
10	38	26	19

ST8 CONSTRUCTION

INLINE CEILING MOUNT

- The **ST88** (8 ft.), **ST86** (6 ft.), **ST84** (4 ft.), and **ST83** (3 ft.) series are ceiling mount fixtures that may be used as stand-alone units or connected in continuous runs.
- Projections are available in standard lengths of 6, 12, 18 and 24 inches. Also available in custom lengths (specify). Maximum 48".
- Zinc aluminum alloy and aluminum extrusion, with a matte anodized finish.
- G5 twist-in lamp holders.
- Standard output electronic ballasts are 120/277V, 50/60 Hz universal, in a remote housing.
- Back plate has a 7/8" opening for direct conduit feed and is not intended for J-box mount.
- C.U.L. listed for damp locations.

CONTINUOUS MOUNT INFORMATION

Follow instructions for rail or remote ballast installation. Be certain to join right, left and middle fixtures accordingly. Slide connector to ensure proper alignment of adjacent fixtures. **Does not connect stand alone fixtures.**

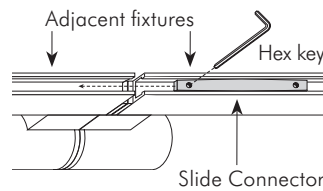

SRB REMOTE BALLAST MOUNT

SRB OPTION: For T-bar and accessible ceilings only. Make lamp wire connections in a horizontally mounted 2x4 handy box. The ballast box must be accessible after installation.

*Lamp-to-ballast distance must not exceed 16 feet for a 4 ft. fixture, 8 feet for an 8 ft. fixture.

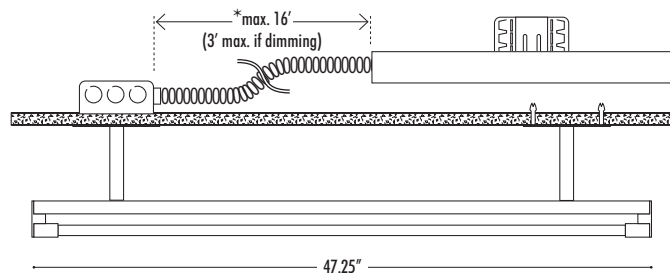

SRB85 – 2" x 4" rectangular cover plates that mount directly to standard handy boxes.



SRB8R – 4" round cover plates that mount to mud rings.

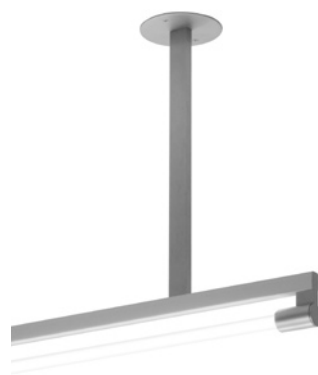

OPTIONS

EMERGENCY BALLASTS

Emergency ballast provides 650 lumens for 90 minutes. Charge light and test switch are visible from below. EM for 28/54W lamps *only*. Voltage must be specified. Order **SEM**.

DIMMING BALLASTS

Note: Dimming available for 4 ft. lamps only; maximum projection length: 3 ft.

Cat. #	Type	Wattage
SD3	Advance Mark X	54
SD5	Advance Mark VII	54
SD8	Lutron Hi Lume FDB	28/54
SD9	Lutron Eco System	28/54
SD10	Stepped dim, 50% for 2x28 only	2x28

BALLAST/RAIL MOUNT INFO

Stick ballast and rail housings are shipped with one opening for direct connection to conduit with a third party 1/2" fitting (as shown below). To locate input power elsewhere, an alternate 7/8" opening may be drilled at the job site anywhere along the top of the aluminum rail housing.

